

**BEVEL SEAT GASKET**

DATE  
: 07/09/2026 12:58 AM

SKU  
: 4445

BRAND  
: DIXON VALVE

MODEL  
: 40BS-H400

Specifications:  
Meets 21CFR 177.1550  
Passed U.S.P. Class VI Cytotoxicity testing

Safety notes:  
WARNING: Cancer and Reproductive Harm- [www.P65Warnings.ca.gov](http://www.P65Warnings.ca.gov)

**TECHNICAL SPECIFICATIONS**

<b>Color</b>	White
<b>Color Code</b>	no dot
<b>Material</b>	Heavy PTFE
<b>Factory Part Number</b>	40BS-H400
<b>Size</b>	4"
<b>Weight Lb</b>	0.0800

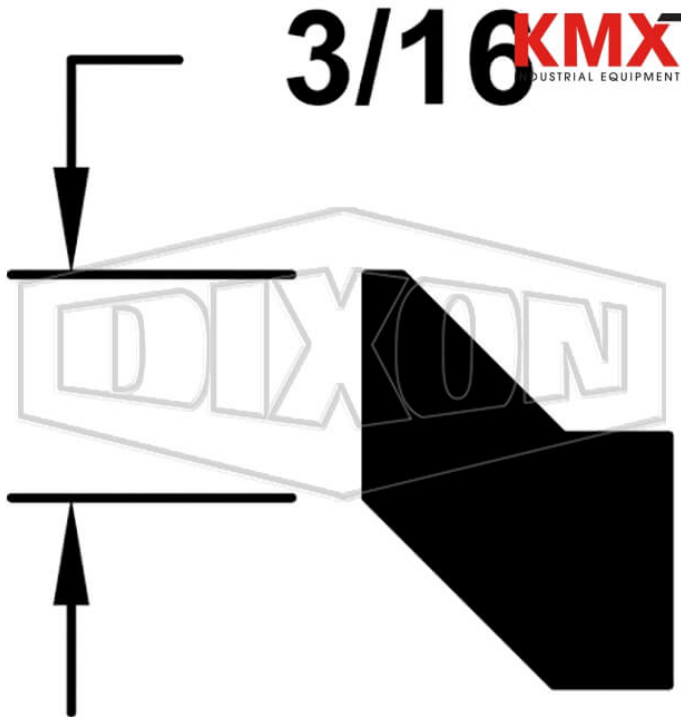

\* Referential image  
\*\* Some features may vary without prior notice. Sale subject to inventory availability