

BEVEL SEAT GASKET

DATE
: 07/09/2026 12:58 AM

SKU
: 4444

BRAND
: DIXON VALVE

MODEL
: 40BS-H300

Specifications:
Meets 21CFR 177.1550
Passed U.S.P. Class VI Cytotoxicity testing

Safety notes:
WARNING: Cancer and Reproductive Harm- www.P65Warnings.ca.gov

TECHNICAL SPECIFICATIONS

Color	White
Color Code	no dot
Material	Heavy PTFE
Factory Part Number	40BS-H300
Size	3"
Weight Lb	0.0450

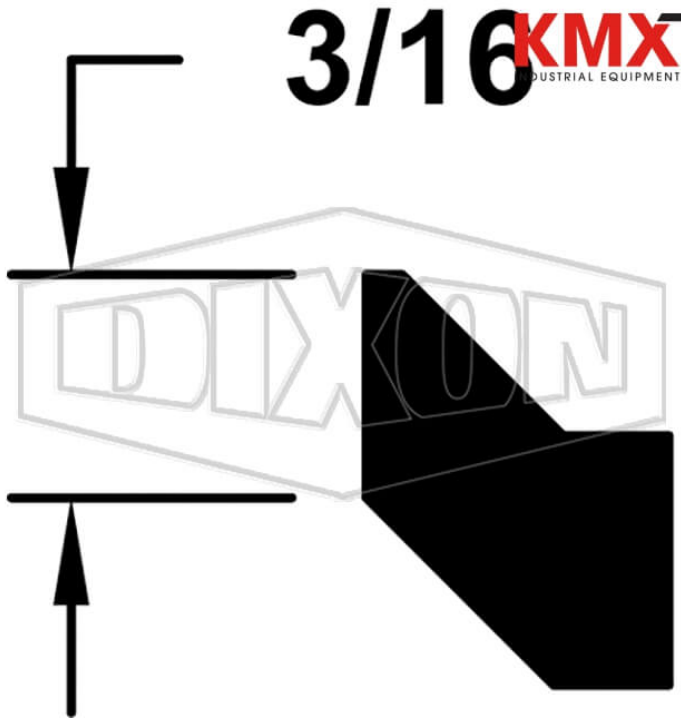

* Referential image
** Some features may vary without prior notice. Sale subject to inventory availability